

CAVE-TEK

TeamUp S12 Camera

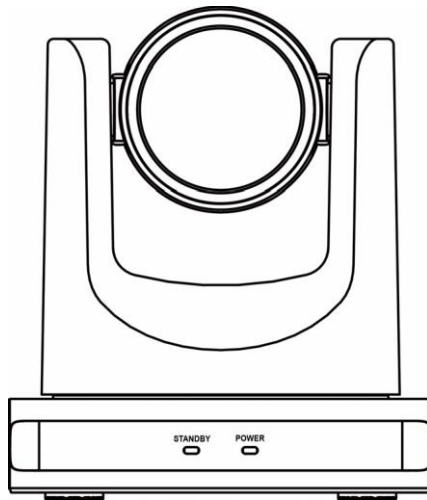

User Guide
English (V1.0)

Table of content

1	Packing List	1
2	Quick Start	1
3	About S12	2
3.1	Interfaces	2
3.2	Dimension	2
3.3	Remote Control	3
3.4	RS-232 Interface	4
3.5	Serial Communication Control	4
4	GUI Settings	5
4.1	MENU	5
4.2	EXPOSURE	5
4.3	COLOR	6
4.4	IMAGE	6
4.5	P/T/Z	7
4.6	NOISE REDUCTION	7
4.7	SETUP	錯誤! 尚未定義書籤。
4.8	SETUP	8
4.9	COMMUNICATION SETUP	8
4.10	RESTORE DEFAULT	8
5	Network Function	9
5.1	Operating Environment	9
5.2	Equipment Installation	9
5.3	Internet Connection	9
5.4	Camera controlled by LAN	9
5.4.1	Setup IP address	9
5.4.2	Login IP Camera admin	10
5.4.3	Open Network stream with VLC player	11
5.5	Camera Setup	12
5.5.1	Homepage Introduction	12
5.5.2	Video Settings	14
5.5.3	Image Settings	15
5.5.4	Audio Settings	16
5.5.5	System Settings	17
5.5.6	Network Settings	17
5.5.7	Device Information	18

1 Packing List

Open the box, you will find below items:

Name	Quantity
TeamUp S12 Camera	1
AC Power Adaptor	1
Power Cable	1
USB Cable	1
Remote Control	1
Quick Installation Guide	1

2 Quick Start

- 1) Please check below connection diagram first.
- 2) Connect the power adaptor to the power connector on the rear panel of the camera. The power indicator on the front panel of the camera is on.
- 3) After the camera is powered on, it starts to boot up to the initialization position. Then both horizontal and vertical go to the middle position, the motor stops running, and the initialization is completed.
(Note: If preset 0 is saved, Camera will be moved to preset 0)

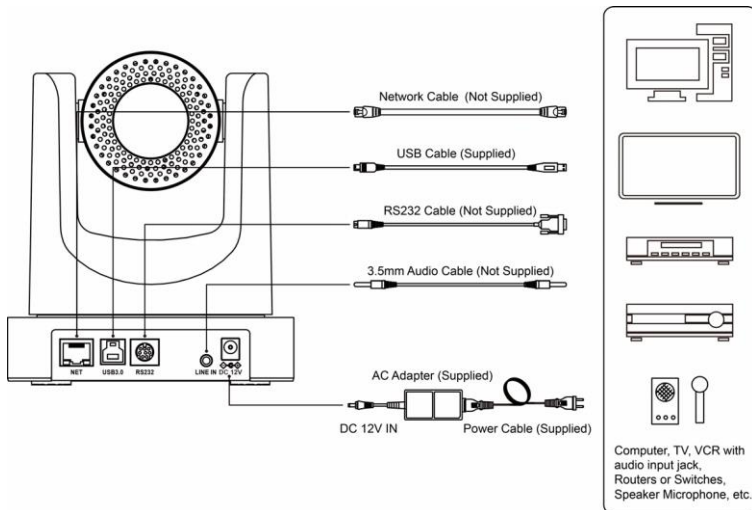

3 About S12

3.1 Interfaces

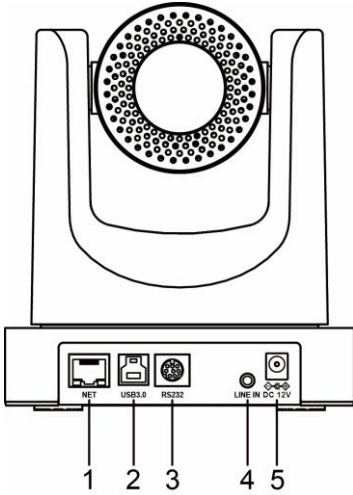

Item	Name
1	Network Interface
2	USB 3.0 Interface
3	RS232 IN Interface
4	LINE IN Interface
5	DC 12V Interface

3.2 Dimension

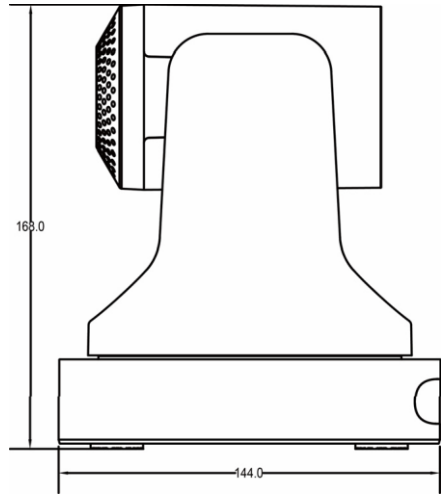
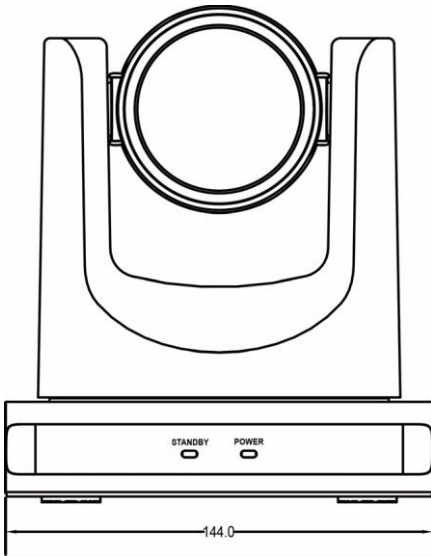

3.3 Remote Control

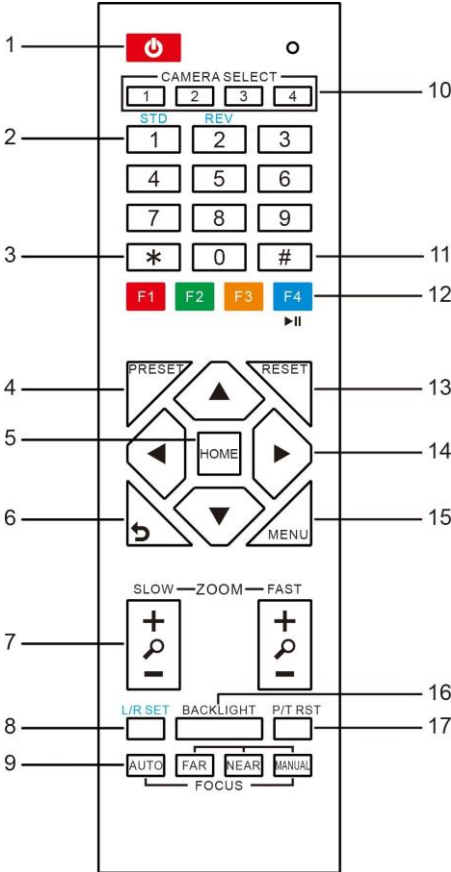

Key Description

1. Standby Key

Press this button to enter standby mode. Press it again to enter normal mode.

2. Number Key

To set preset or call preset.

3. *Key

To configure the special function key.

4. Preset Key

Set preset: Store a preset position.
[SET PRESET] + Numeric button (0-9): Setting a corresponding numeric key preset position.

5. HOME Key

Confirm the selection, or move the camera back to the middle position

6. Return Key

Return to the previous menu

7. Zoom Key

Slow Zoom: Zoom In [+] or Zoom Out [-] slowly

Fast Zoom: Zoom In [+] or Zoom Out [-] fast

8. Left/Right Setting Key

Press with 1 button and 2 buttons setting the direction of the Pan-Tilt.

- Simultaneously press L/R Set +1[STD]: set the Pan-Tilt to turn the same direction as the L/R Set.
- Simultaneously press L/R Set +2[REV]: set the Pan-Tilt to turn the opposite direction as the L/R Set.

9. Focus Key

To adjust the focus.

Press [AUTO] adjust the focuses on the center of the object automatically. Or to adjust the focus manually.

Press [MANUAL] adjusts the focus on the center of the object manual.

10. Selection Key

Press the button corresponding to the camera you want to operate with the remote controller.

11. #Key

To configure the special function key.

12. IR Remote Control Key

[*]+[#]+[F1]: Address 1

[*]+[#]+[F2]: Address 2

[*]+[#]+[F3]: Address 3

[*]+[#]+[F4]: Address 4

13. Reset Key

Clear preset: Erase a preset position.

[CLEAR PRESET] + Numeric button (0-9)

Or: [*]+[#]+[CLEAR PRESET]: Erase all the preset individually.

14. PTZ Control Key

Press arrow buttons to perform panning and tilting. Press [HOME] button to face the camera back to front.

15. Menu Key

MENU: enter or exit OSD MENU.

16. Backlight Key

BLC ON/OFF: Press this button to enable the backlight compensation. Press it again to disable the backlight compensation.

17. PTZ Reset Key

Preset Pan/Tilt self-test.

18. Special Function Key

[*]+[#]+[1]: Change OSD menu to English

[*]+[#]+[4]: Display current IP address

[*]+[#]+[6]: Reset to system defaults

[*]+[#]+[8]: Display camera firmware Info.

[*]+[#]+[9]: set mounting mode (normal / vertical flip)

[#]+[*]+[4]: Set Network configuration to DHCP

[*]+[#]+[Manual]: Reset network to default.

[*]+[#]+[F1]: Assign Camera to IR Address 1

[*]+[#]+[F2]: Assign Camera to IR Address 2

[*]+[#]+[F3]: Assign Camera to IR Address 3

[*]+[#]+[F4]: Assign Camera to IR Address 4

3.4 RS-232 Interface

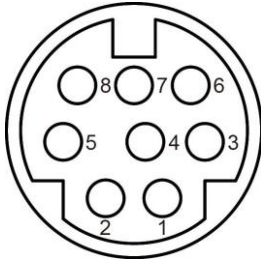

No.	Function
1	DTR
2	DSR
3	TXD
4	GND
5	RXD
6	GND
7	IR OUT
8	NC

The correspondence between the camera and Windows DB-9 pin:

Camera	Windows DB-9
1.DTR	1.CD
2.DSR	2.RXD
3.TXD	3.TXD
4.GND	4.DTR
5.RXD	5.GND
6.GND	6.DSR
7.IR OUT	7.RTS
8.NC	8.CTS
	9.RI

The correspondence between the camera and the Mini DIN pin:

Camera	Mini DIN
1.DTR	1.DTR
2.DSR	2.DSR
3.TXD	3.TXD
4.GND	4.GND
5.RXD	5.RXD
6.GND	6.GND
7.IR OUT	7.NC
8.NC	8.NC

3.5 Serial Communication Control

- **RS232 Communication Control**

The camera is controlled via RS232. The RS232 serial port parameters are as follows:

Baud rate: 2400/4800/9600/38400 bit/s;

Starting Position: 1 bit

Data bit: 8 bits

Stop bit: 1 bit

Check digit: None

- **List of protocols**

For a detailed list of VISCA/Pelco-D/Pelco-P protocols, please check www.cave-tek.com.

4 GUI Settings

4.1 MENU

Press the [MENU] button to display the main menu on the display, using the arrow button to move the cursor to the item. Press the [HOME] button to enter the corresponding sub-menu.

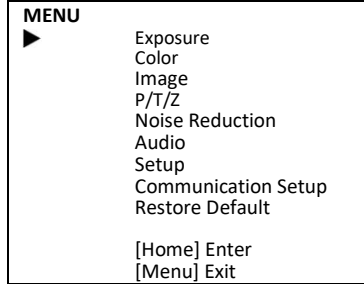

4.2 EXPOSURE

Move the main menu cursor to [EXPOSURE], and press [HOME] key enter the exposure page, as shown in the following figure.

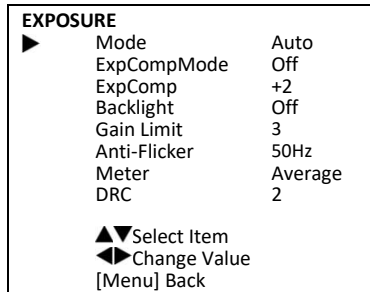

Mode: Exposure mode, Auto, Manual, SAE, AAE, Bright.

ExpCompMode: Exposure the compensation mode, On, Off (Effective only in Auto mode).

ExpComp: Exposure the compensation value. Value: -7~7 (Effective only in ExpCompMode item to On).

Backlight: Set the backlight compensation, On, Off (Effective only in Auto mode).

Bright: Intensity control, 0~17 (Effective only in Bright mode).

Gain Limit: Maximum gain limit, 0 ~ 15 (Effective only in Auto, SAE, AAE, Bright mode).

Anti-Flicker: Anti-flicker, Off, 50Hz, 60Hz (Effective only in Auto, AAE, Bright mode).

Meter: Average, Center, Smart, Top.

Gain: 0 ~ 7 (Effective only in Manual mode).

DRC: DRC strength, optional items: 0 ~ 8.

4.3 COLOR

Move the main menu cursor to [COLOR], and press [HOME] key enter the color page, as shown in the following figure.

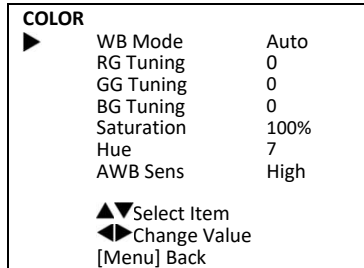

WB-Mode: White balance mode: Auto, Indoor, Outdoor, One Push, Manual, VAR.

RG Tuning: Red gain fine-tuning: -10 ~ +10 (Effective only in Auto, One Push, VAR mode).

BG Tuning: Blue gain fine-tuning: -10 ~ +10 (Effective only in Auto, One Push, VAR mode).

Saturation: 60% ~ 200%.

Hue: 0 ~ 14.

AWB Sens: The white balance sensitivity: Low, Middle, High.

RG: Red gain: 0~255 (Effective only in Manual mode).

BG: Blue gain: 0~255 (Effective only in Manual mode).

Color temp: 2500K ~ 8000K (Effective only in VAR mode).

4.4 IMAGE

Move the main menu cursor to [IMAGE], and press [HOME] key enter the image page, as shown in the following figure.

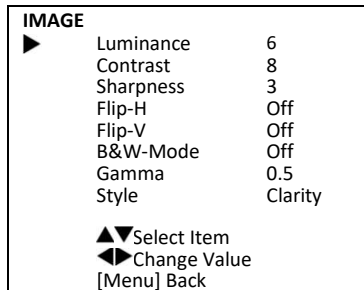

Luminance: 0 ~ 14.

Contrast: 0 ~ 14.

Sharpness: Auto, 0 ~ 15.

Flip-H: On, Off.

Flip-V: On, Off.

B&W-Mode: On, Off.

Gamma: Default, 0.45, 0.5, 0.56, 0.63.

Style: Default.

4.5 P/T/Z

Move the main menu cursor to [P/T/Z], and press [HOME] key enter the P/T/Z page, as shown in the following figure.

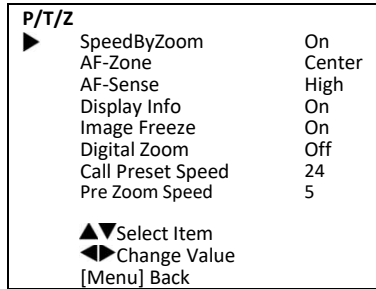

- SpeedByZoom:** The depth of field scale switch: On, Off.
- AF-Zone:** Interested in focusing area: Top, Center, Bottom.
- AF-Sense:** Automatic focusing sensitivity options: Low, Normal, High.
- Display Info:** On, Off.
- Image Freeze:** On, Off.
- Digital Zoom:** Off, 2x, 4x, 8x, 16x.
- Call Preset Speed:** 1 ~ 24.
- Pre Zoom Speed:** 0 ~ 7.

4.6 NOISE REDUCTION

Move the main menu cursor to [NOISE REDUCTION], and press [HOME] key enter the noise reduction page, as shown in the following figure.

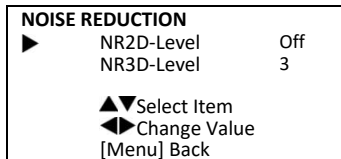

- NR2D Level:** 2D noise reduction: Off, Auto, 1 ~ 5.
- NR3D Level:** 3D noise reduction: Off, 1 ~ 8.

4.7 AUDIO

Move the main menu cursor to [AUDIO], and press [HOME] key enter the audio page, as shown in the following figure.

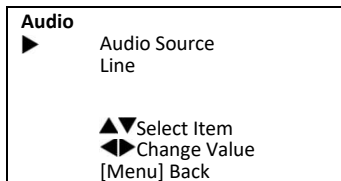

4.8 SETUP

Move the main menu cursor to [SETUP], and press [HOME] key enter the setup page, as below.

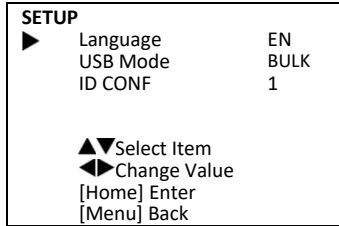

Language: EN, Chinese, Russian.

USB Mode: BULK, ISOC.

ID CONF: 1,2

4.9 COMMUNICATION SETUP

Move the main menu cursor to [COMMUNICATION SETUP], and press [HOME] key enter the communication setup page, as shown in the following figure.

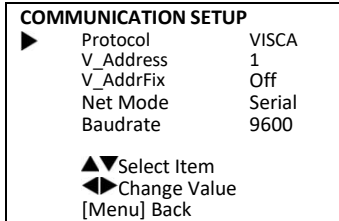

Protocol: Control protocol type: Auto, VISCA, PELCO-D, PELCO-P.

V_Address: 1 ~ 7. (Effective only in Auto, VISCA protocol).

V_AddrFix: On, Off (When set to On, useless in 88 30 01 FF Command).

P_D_Address: 0 ~ 254. (Effective only in PELCO-D protocol).

P_P_Address: 0 ~ 31. (Effective only in PELCO-P protocol).

Net Mode: Set the serial port network control: Serial, Paral.

Baudrate: Serial port baud rate: 2400, 4800, 9600, 38400.

4.10 RESTORE DEFAULT

Move the main menu cursor to [RESTORE DEFAULT], and press [HOME] key enter the restore default page, as shown in the following figure.

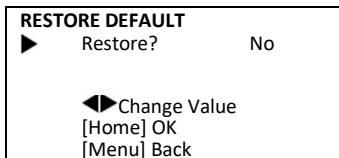

Restore: Confirm restore factory settings: Yes, No.

Note: Press [HOME] button to confirm, all parameter restore default, include IR Remote address and VISCA address.

5 Network Function

5.1 Operating Environment

Operating System: Windows 7/8/10, Mac OS X, Linux, Android

Network Protocol: TCP/IP

System Requirement: Intel Duo Core /256M RAM/40G HDD/ Graphics card support DirectX 9.0 or later version.

5.2 Equipment Installation

- 1) Connect internet camera to your internet or to your PC directly via network cable.
- 2) Turn on DC 12V power.
- 3) If the network connection is normal, the connection light (green) at the network interface will light up within 5 seconds. The data indicator (orange) will flash, indicating that the camera's physical connection has been completed.

5.3 Internet Connection

There are two main ways to connect network camera.

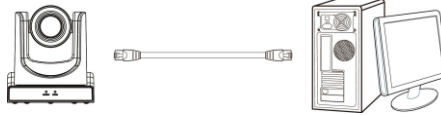

Connect by Network Cable



Connect by Switch/Router

5.4 Camera controlled by LAN

5.4.1 Setup IP address

If you don't know the camera IP, view as below:

Method 1: Press * and # and 4 on the remote controller one by one; the camera IP address will be shown on screen.

Change IP address, two methods as below:

Method 1: Login to the web page, select "Network > Lan Settings," change IP address. Click "Apply" then restart the camera.

Method 2: Press * and # and Manual on the remote controller one by one; the camera IP address will restore to the default IP address (192.168.100.88).

The screenshot shows a configuration page for an IP camera with the following sections:

- Lan Settings:** IP Configuration Type (Fixed IP Address), IP Address (192.168.100.88), Subnet Mask (255.255.255.0), Gateway (192.168.100.1), DNS Address, MAC Address (D4 E0 8E 5A 3A 13). Buttons: Apply, Cancel.
- Port Settings:** HTTP Port number (80), RTSP Port (554), PTZ Port (5678).
- Control Protocol Settings:** Visca Address (1), Pelco-D Address (0), Pelco-P Address (0).
- RTMP Settings:** First stream (On/Off, Video/Audio), MRL (rtmp://192.168.100.138/live/stream0), Second stream (On/Off, Video/Audio), MRL (rtmp://192.168.100.138/live/stream1).
- RTSP Settings:** RTSP Auth (On/Off).
- ONVIF Settings:** ONVIF (On/Off), ONVIF Auth (On/Off).
- Multicast Settings:** Multicast (On/Off), Address (224.1.2.3), Port (6688).
- SDK Settings:** Active Connection (On/Off), Address (192.168.100.138), Port (1234).
- NTP Settings:** NTP time sync (On/Off), Server address, Time interval (1440 minutes), Main time show (On/Off), Position (X:0, Y:0), Sub time show (On/Off), Position (X:0, Y:0). Buttons: Apply, Cancel.

Note: IP camera default IP address "192.168.100.88", the username is "admin", password is "admin".

5.4.2 Login IP Camera admin

Enter 192.168.100.88 on browser, a login window pop up, input login name: admin, password: admin, shown as below:



After login, shown as below:



Note: If users first use this camera by internet (only for new user), they must install a player software (VLC). Please go to VLC website <http://www.videolan.org/vlc/#download> and Install VLC (player software). After installation, login again, will show as above.

5.4.3 Open Network stream with VLC player

Step 1 Open VLC media player.

Step 2 Click "Media > Open Network Stream", or click "Ctrl + N"; as below:

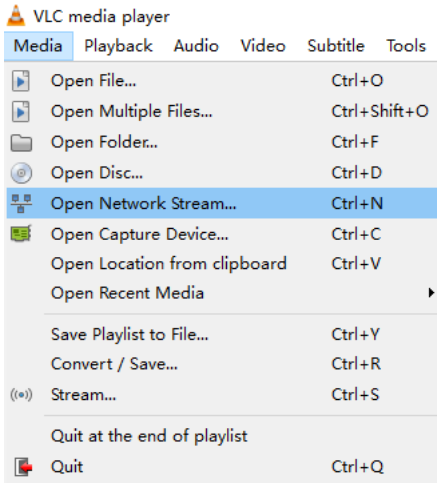

Step 3 Input URL address:
rtsp://ip: port number/1 (First stream);
rtsp://ip: port number/2 (Second stream).

Step 4 Finish.

Note: RTSP default port number 554.

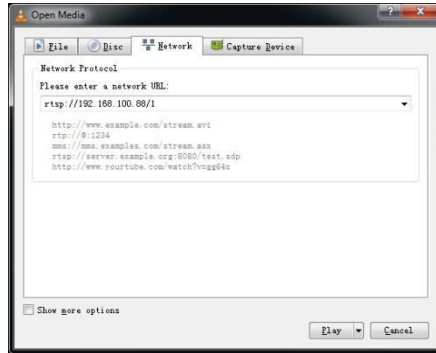

5.5 Camera Setup

5.5.1 Homepage Introduction

A. Preview window

- 1) Video playback pause button: control real-time video pause, stop the last picture, click recoverable video again.
- 2) Audio control buttons: can set silent mode.
- 3) Full-screen switch button.

B. PTZ Setup

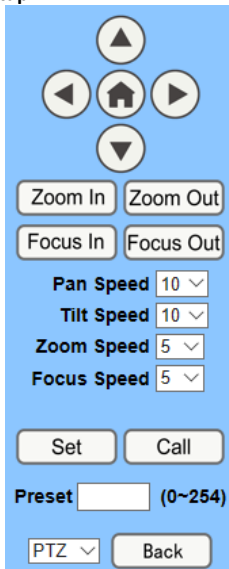

PTZ direction control box: Up, down, left, right, home button as above.

Rate: Pan Speed can be chosen as 1 ~ 24, Tilt Speed can be chosen as 1 ~ 20.

Select the corresponding speed and click the direction button to realize PTZ speed up or speed down.

Zoom In/Zoom out: For zooming in or zooming out. Focus In/Focus Out: Focusing on distant the objects or focusing on close the objects.

Set/Call: When PTZ turns to the expected position, set up the preset that the user wants as below.

Method 1: Type a number into the Preset box.

Method 2: Type the name into the Presets Information.

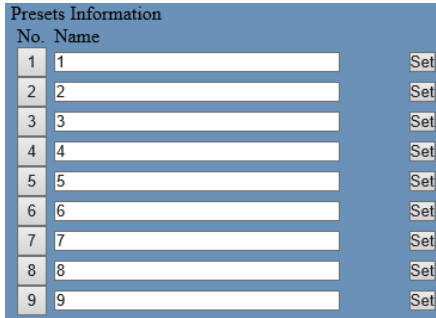

Presets Information		
No.	Name	
1	<input type="text"/>	Set
2	<input type="text"/>	Set
3	<input type="text"/>	Set
4	<input type="text"/>	Set
5	<input type="text"/>	Set
6	<input type="text"/>	Set
7	<input type="text"/>	Set
8	<input type="text"/>	Set
9	<input type="text"/>	Set

Click "Set" button, when PTZ turn to other position, click "Call" button or click "No." of the Presets Information, PTZ will turn back to preset position.

PTZ / MENU: When system in menu mode, OSD menu display in the upper corner of the image page. PTZ direction control box: Up/down button select menu, and the home button enter the submenu, the left/right button modify the submenu. After the menu to be modified, select PTZ. If in the main menu, save the setting and exit automatically. Otherwise, return to the previous menu.

PTZ: system in PTZ mode.

C. Language selection

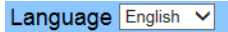

Change Language: Chinese/English/Russian

5.5.2 Video Settings

The screenshot shows a 'Video Settings' window with a blue background. It is divided into sections: 'Video Settings', 'First stream', and 'Second stream'. Each section contains various configuration options with dropdown menus, text inputs, and radio buttons. At the bottom right, there are 'Apply' and 'Cancel' buttons.

Video Settings

Video Format:
Encode Level:

First stream

Encode Protocol:
Resolution:
Bit Rate: (32~20480) kbps
Frame Rate: fps
I Key Frame Interval: (2~150)
Bit Rate Control: CBR VBR
Fluctuate Level:
Slice Split Enable: On Off
Split Mode: Fixed blocks Fixed bytes
Slice Size: blocks/bytes

Second stream

Encode Protocol:
Resolution:
Bit Rate: (32~6144) kbps
Frame Rate: fps
I Key Frame Interval: (2~150)
Bit Rate Control: CBR VBR
Fluctuate Level:
Slice Split Enable: On Off
Split Mode: Fixed blocks Fixed bytes
Slice Size: blocks/bytes

1) Video Format

Support 50Hz (PAL) and 60Hz (NTSC), and Dial Priority three formats.

2) Encode Level

Support baseline, mainprofile, highprofile and svc-t four levels.

3) Encode Protocol

Support H.264, H.265 and MJPEG three formats.

4) Resolution

First stream support 1920x1080, 1280x720, 1024x576, 960x540, 640x480, 640x360. Second stream support 1280x720, 1024x576, 720x576 (50Hz support), 720x480 (60Hz support), 720x408, 640x360, 480x270, 320x240, 320x180; The bigger resolution is, the clearer the image will be, more network bandwidth will be taken.

5) Bit Rate

The user can specify the bit rate. Generally speaking, the larger the bit rate, the better image quality.

However, the configuration of the bit rate needs to be adjusted according to the actual network condition.

When the network bandwidth is low, if you configure the bit rate in a large value, the video stream cannot

be transmitted smoothly and the visual effect become very poor.

6) Frame Rate

User can specify the frame rate's size, generally speaking, the bigger frame rate value, the image more smooth; Frame rate is smaller, the video might be leggy.

7) I Key Frame Interval

Set interval between 2 I frame, the bigger interval is the response will be lower from viewing window.

8) Bit Rate Control

Constant Bit Rate: Video encoder will be encoding according to preset speed.

Variable Bit Rate: Video encoder will adjust the speed based on preset speed to gain the best image quality.

9) Fluctuate Level

Restrain the fluctuation magnitude of variable rate, grade 1 ~ 6.

10) Slice Split Enable

Enable or disable slice split function.

11) Split Mode

Select split mode, optional items: Fixed blocks, Fixed bytes.

12) Slice Size

Set the size of slice.

5.5.3 Image Settings

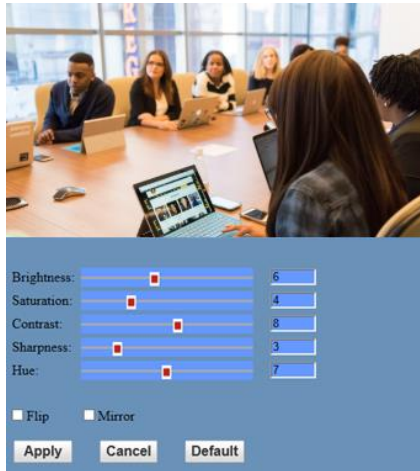

1) Brightness

Image bright 0~14, slider control, on the right shows the corresponding numerical. Default value is 6.

2) Saturation

Saturation 0~14, slider control, on the right shows the corresponding numerical. Default value is 4.

3) Contrast

Contrast 0~14, slider control, on the right shows the corresponding numerical. Default value is 8.

4) Sharpness

Sharpness 0~15, slider control, on the right shows the corresponding numerical. Default value is 3.

5) Hue

Hue 0~14, slider control, on the right shows the corresponding numerical.

Default value is 7.

6) Flip & Mirror

Tick Flip to realize image upside down, tick mirror to realize image around the mirror. Default value is not tick.

5.5.4 Audio Settings

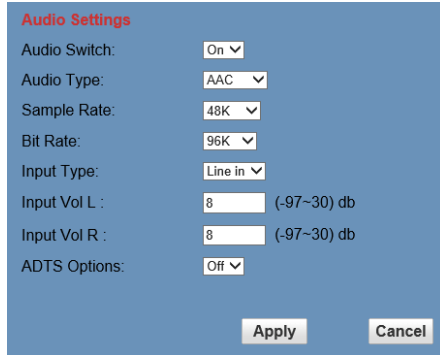

1) Audio Switch

Enable or disable audio switch.

2) Audio Type

Audio type AAC.

3) Sample Rate

Sample rate 44.1K and 48K selectable.

4) Bit Rate

Bit rate 96K, 128K, 256K selectable.

5) Input Type

Input type line in.

6) Input Vol L

The volume of the left channel.

7) Input Vol R

The volume of the right channel.

8) ADTS Options

Optional items: On, Off.

5.5.5 System Settings

1) Work Mode

The default work mode is RTSP.

Optional items: RTSP, SDK, Multicast.

2) Reboot

Click the "Reboot" button, system restart.

3) Username and password

The user can modify the password (letters and numbers only).

5.5.6 Network Settings

1) LAN Settings

Default the IP address is 192.168.100.88, the MAC address can not be modified.

2) Port Settings

A. HTTP Port

The port setting is to set up a web server program using which port to transmit. When port mapping, need to be consistent with the port number (default port: 80).

B. RTSP Port

Network camera support RTSP protocol, use the VLC tools broadcast.

C. PTZ Port

Support PTZ protocol, default port: 5678.

3) Control Protocol Settings

Setting the camera control communication protocol, include Visca address, Pelco-D address, and Pelco-P address.

4) RTMP Settings

Setting the MRL of RTMP, select enable or disable video and audio. You can select the control code stream of "On", "Off", "Video", "Audio" between in the two streams.

5) RTSP Settings

Turn On/Off RTSP auth.

6) ONVIF Settings

Turn On/Off ONVIF and ONVIF auth.

7) Multicast Settings

Turn On/Off multicast. Setting the multicast address (default value is 224.1.2.3) and port (default value is 6688, then 6688 is the multicast port of the first stream; 6690 is the multicast port of the second stream).

8) SDK Settings

Turn On/Off active connection. Setting SDK address (default value is 192.168.100.138) and port (default value is 1234).

9) NTP Settings

Turn On/Off NTP time sync, main time show and sub time show. Setting NTP server address, time interval, primary stream position and sub stream part.

5.5.7 Device Information

Display the current device information, as shown below.

